

Showcase humidity and temperature sensors ( $\pm 2.0\%$ ),  
calibratable, with multi-range switching  
and active output

The calibratable humidity and temperature sensor **HYGRASGARD® VFF / VFTF** measures the relative humidity and temperature of air. It converts the measurands humidity and temperature into a standard signal of 0-10V or 4...20mA, and is available with / without an optional display. It is equipped with four switchable temperature ranges. Relative humidity (in %r.H.) is the quotient of water vapour partial pressure divided by the saturation vapour pressure at the respective gas temperature. The measuring transducers are designed for exact detection of temperature and humidity. A digital, long-term stable sensor is used as a measuring element for humidity and temperature measurement. The sensor is factory-calibrated; an environmental precision adjustment by an expert is possible.

The showcase sensor is used in non-aggressive, dust-free environments and is specifically designed for installation in ceilings, walls, inside showcases or display cabinets in museums, galleries, cinemas or lecture halls or laboratories. The measuring element is contained inside a stainless steel probe and its low height (approx. 2.5 mm) makes it barely noticeable.

#### TECHNICAL DATA

Power supply:	24 V AC ( $\pm 20\%$ ) and 15...36 V DC for U variant 15...36 V DC for I variant, depending on working resistance, residual ripple stabilised $\pm 0.3$ V
Working resistance:	$R_a$ (Ohm) = $(U_b - 14 V) / 0.02 A$ for I variant
Load resistance:	$R_L > 5 k\Omega$ for U variant
Power consumption:	$< 1.1 VA / 24 V DC$ ; $< 2.2 VA / 24 V AC$
Sensors:	<b>digital humidity sensor with integrated temperature sensor</b> , low hysteresis, high long-term stability

#### HUMIDITY

Measuring range, humidity:	0...100% r.H. (output corresponding to 0-10V or 4...20mA)
Operating range, humidity:	0...95% r.H. (without formation of dew)
Deviation in humidity:	typically $\pm 2.0\%$ (20...80% r.H.) at $+25^\circ C$ , otherwise $\pm 3.0\%$
Output, humidity:	0-10V for U variant 4...20 mA for I variant, see load resistance diagram

#### TEMPERATURE

Measuring range, temperature:	<b>multi-range switching with 4 switchable measuring ranges</b> (see table) $-35...+35^\circ C$ ; $-35...+75^\circ C$ ; $0...+50^\circ C$ ; $0...+80^\circ C$ (output corresponding to 0-10V or 4...20mA)
Deviation, temperature:	typically $\pm 0.2 K$ at $+25^\circ C$
Output, temperature:	0-10V or 4...20mA
Ambient temperature:	storage $-5...+60^\circ C$ ; operation $-5...+60^\circ C$
Long-term stability:	$\pm 1\%$ per year

Housing:	plastic, UV-resistant, material polyamide, 30% glass-globe reinforced, with quick-locking screws (slotted / Phillips head combination), colour traffic white (similar to RAL 9016), housing cover for display is transparent!
Housing dimensions:	72 x 64 x 37.8 mm (Tyr 1 without display) 72 x 64 x 43.3 mm (Tyr 1 with display)

Cable connection:	<b>cable gland</b> , plastic (M 16 x 1.5; with strain relief, exchangeable, max. inner diameter 10.4 mm) or <b>M12 connector</b> according to DIN EN 61076-2-101 (optional on request)
Electrical connection:	2-, 3-, or 4-wire connection (see connecting diagram), 0.14 - 1.5 mm <sup>2</sup> , via terminal screws
Connecting cable:	PVC, LiYY, 4 x 0.14 mm <sup>2</sup> , cable length (KL) = 2 m

Sensor protection:	<b>probe</b> made of stainless steel, <b>V4A</b> (1.4571), <b>pluggable</b> ; sensor head $\varnothing = 17$ mm, H = approx. 2.5 mm; protective sleeve $\varnothing = 10$ mm, NL = approx. 25 mm, M10 x 1.0; with plastic plug connector $\varnothing =$ approx. 11 mm, NL = approx. 25 mm,
Mounting (sensor):	cut-out $\varnothing = 11 - 15$ mm, inserted length (EL) = approx. 50 mm, lock nut for fixing is included in the scope of delivery.

Protection class:	III (according to EN 60 730)
Protection type:	<b>IP 67</b> (according to EN 60 529) Housing tested, TÜV SÜD, Report No. 713139052 (Tyr 1) <b>IP 65</b> (according to EN 60 529) Probe

Standards:	CE conformity according to EMC Directive 2014 / 30 / EU, according to EN 61326-1, according to EN 61326-2-3
Optional:	two-line <b>display with illumination</b> , cut-out approx. 36 x 15 mm (W x H), for displaying ACTUAL temperature and / or ACTUAL humidity

VFF  
VFTF

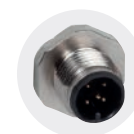

**M12 connector**  
(optional on request)

VFF  
VFTF

Probe made of stainless steel,  
pluggable





Dimensional drawing

VFF  
VFTF

VFF  
VFTF  
with display

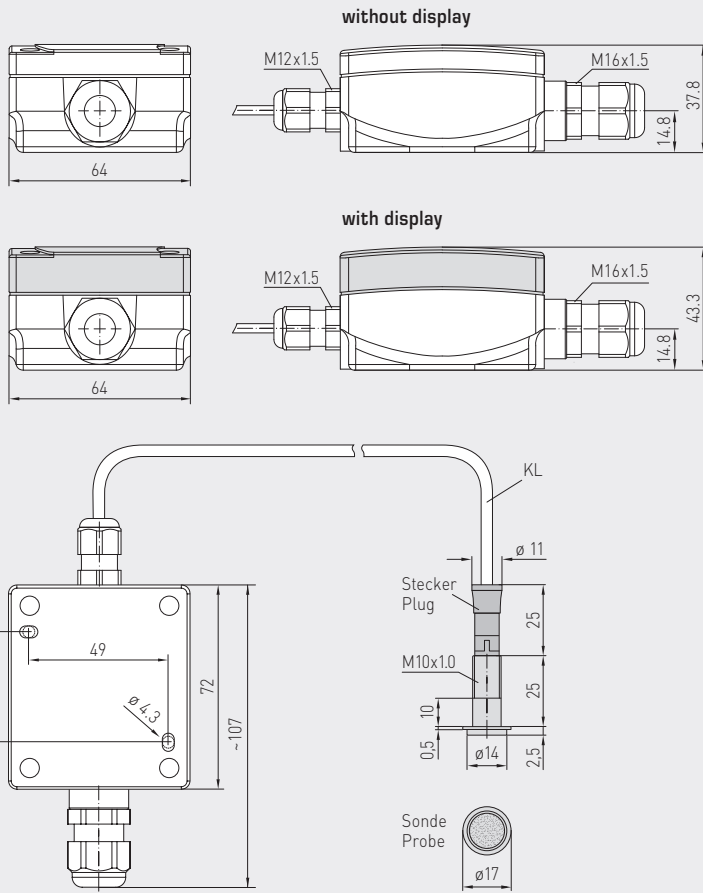

Temperature table  
MR: -35...+75 °C

°C	U <sub>A</sub> in V	I <sub>A</sub> in mA
-35	0.0	4.0
-30	0.5	4.7
-25	0.9	5.5
-20	1.4	6.2
-15	1.8	6.9
-10	2.3	7.6
-5	2.7	8.4
0	3.2	9.1
5	3.6	9.8
10	4.1	10.5
15	4.5	11.3
20	5.0	12.0
25	5.5	12.7
30	5.9	13.5
35	6.4	14.2
40	6.8	14.9
45	7.3	15.6
50	7.7	16.4
55	8.2	17.1
60	8.6	17.8
65	9.1	18.5
70	9.5	19.2
75	10.0	20.0

Temperature table  
MR: -35...+35 °C

°C	U <sub>A</sub> in V	I <sub>A</sub> in mA
-35	0.0	4.0
-30	0.7	5.1
-25	1.4	6.3
-20	2.1	7.4
-15	2.9	8.6
-10	3.6	9.7
-5	4.3	10.9
0	5.0	12.0
5	5.7	13.1
10	6.4	14.3
15	7.1	15.4
20	7.9	16.6
25	8.6	17.7
30	9.3	18.9
35	10.0	20.0

Temperature table  
MR: 0...+50 °C

°C	U <sub>A</sub> in V	I <sub>A</sub> in mA
0	0.0	4.0
5	1.0	5.6
10	2.0	7.2
15	3.0	8.8
20	4.0	10.4
25	5.0	12.0
30	6.0	13.6
35	7.0	15.2
40	8.0	16.8
45	9.0	18.4
50	10.0	20.0

Temperature table  
MR: 0...+80 °C

°C	U <sub>A</sub> in V	I <sub>A</sub> in mA
0	0.0	4.0
5	0.6	5.0
10	1.3	6.0
15	1.9	7.0
20	2.5	8.0
25	3.1	9.0
30	3.8	10.0
35	4.4	11.0
40	5.0	12.0
45	5.6	13.0
50	6.3	14.0
55	6.9	15.0
60	7.5	16.0
65	8.1	17.0
70	8.8	18.0
75	9.4	19.0
80	10.0	20.0

Humidity table  
MR: 0...100% r. H.

% r.H.	U <sub>A</sub> in V	I <sub>A</sub> in mA
0	0.0	4.0
5	0.5	4.8
10	1.0	5.6
15	1.5	6.4
20	2.0	7.2
25	2.5	8.0
30	3.0	8.8
35	3.5	9.6
40	4.0	10.4
45	4.5	11.2
50	5.0	12.0
55	5.5	12.8
60	6.0	13.6
65	6.5	14.4
70	7.0	15.2
75	7.5	16.0
80	8.0	16.8
85	8.5	17.6
90	9.0	18.4
95	9.5	19.2
100	10.0	20.0

Showcase humidity and temperature sensors ( $\pm 2.0\%$ ),  
calibratable, with multi-range switching  
and active output

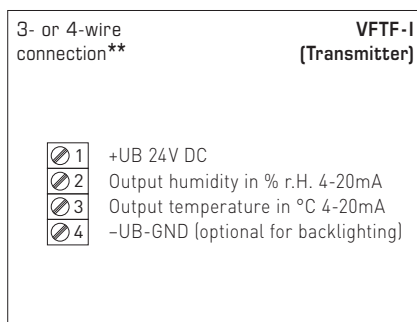
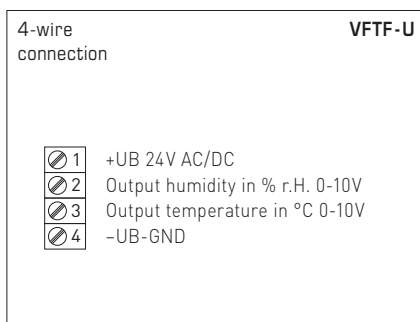
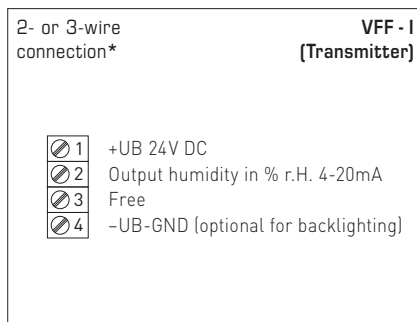
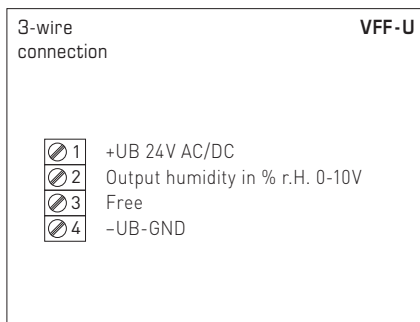
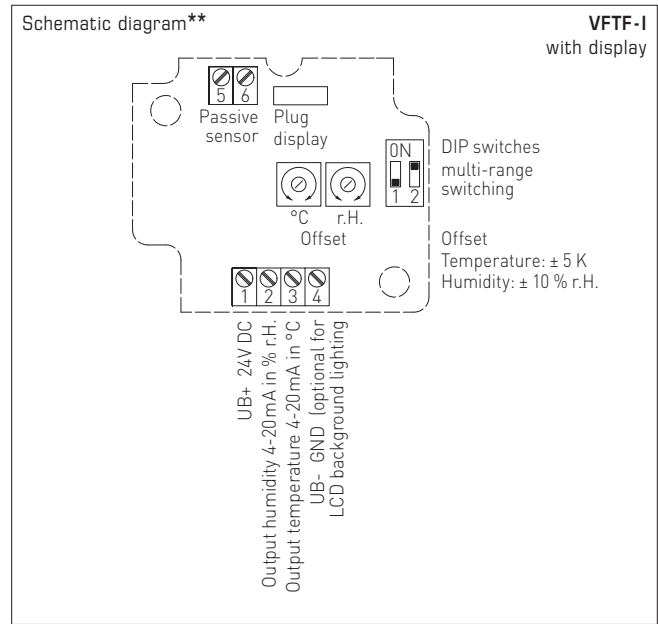
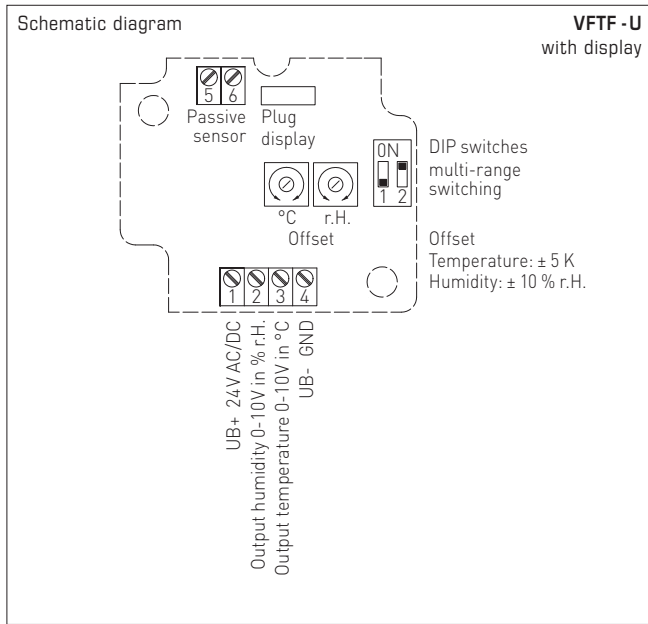

Temperature measuring ranges (adjustable)	DIP 1	DIP 2
-35...+75 °C	ON	ON
-35...+35 °C	OFF	OFF
0...+50 °C (default)	OFF	ON
0...+80 °C	ON	OFF

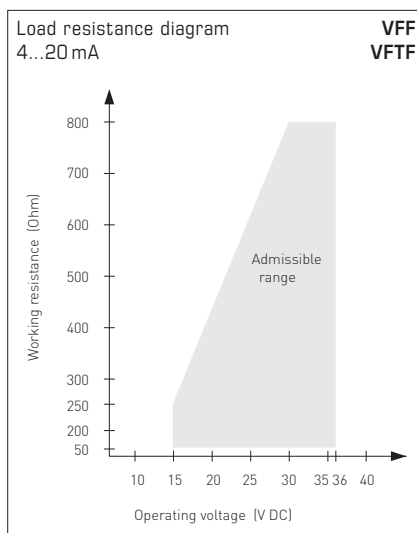

Connection\*:  
2-wire connection for devices with / without display (not illuminated)  
3-wire connection for devices with illuminated display

Connection\*\*:  
3-wire connection for devices with / without display (not illuminated)  
4-wire connection for devices with illuminated display

For the **I variant** the humidity path must be connected!



S+S REGELTECHNIK

HYGRASGARD® VFF  
HYGRASGARD® VFTF

Showcase humidity and temperature sensors ( $\pm 2.0\%$ ),  
calibratable, with multi-range switching  
and active output

VFF  
VFTF  
with display



HYGRASGARD® VFF		Showcase humiditysensor ( $\pm 2.0\%$ ), Premium				
HYGRASGARD® VFTF		Showcase humidity- and temperature sensor ( $\pm 2.0\%$ ), Premium				
Type / WG02	Measuring Range / Readout	Output	Display	Item No.	Price	
	Humidity	Humidity	Humidity			
	Temperature	Temperature	Temperature			
<b>VFF-I</b> I-variant						
VFF-I	0...100% r. H.	–	4...20mA	–	1201-6122-0000-100 440,37 €	
VFF-I LCD	0...100% r. H.	–	4...20mA	–	■ 1201-6122-0200-100 488,93 €	
<b>VFF-U</b> U-variant						
VFF-U	0...100% r. H.	–	0-10V	–	1201-6121-0000-100 440,37 €	
VFF-U LCD	0...100% r. H.	–	0-10V	–	■ 1201-6121-0200-100 488,93 €	
<b>VFTF-I</b> I-variant						
VFTF-I	0...100% r. H.	–35...+75 °C –35...+35 °C 0...+50 °C 0...+80 °C	4...20mA	4...20mA	1201-6122-1000-100 444,32 €	
VFTF-I LCD	0...100% r. H.	(4x as above)	4...20mA	4...20mA	■ 1201-6122-1200-100 493,20 €	
<b>VFTF-U</b> U-variant						
VFTF-U	0...100% r. H.	–35...+75 °C –35...+35 °C 0...+50 °C 0...+80 °C	0-10V	0-10V	1201-6121-1000-100 444,32 €	
VFTF-U LCD	0...100% r. H.	(4x as above)	0-10V	0-10V	■ 1201-6121-1200-100 493,20 €	
Optional:	Cable connection with M12 connector according to DIN EN 61076-2-101				on request	

